



# Assembly Instructions

## GH403 - Freestanding Bathroom Cabinet

### Introduction

Thank you for deciding to purchase this freestanding bathroom cabinet from Sutton Home & Garden. When used correctly it is designed to give many years of reliable, trouble-free service.







### Before Use

Carefully remove all packaging. Avoid using any knives or other sharp instruments as this may damage the surface of the product. Check the product for any visible damage. If you see any damage or suspect a fault, do not use your product, but contact your supplier for support.

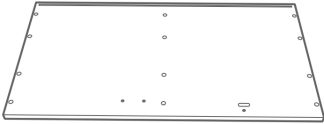
### Cautions

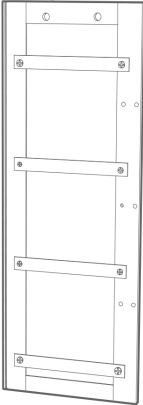
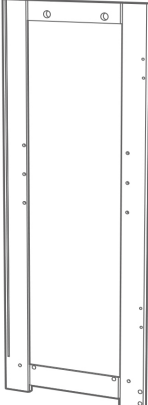
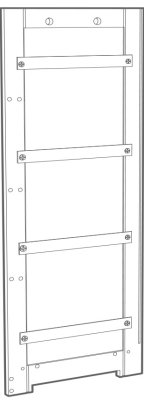

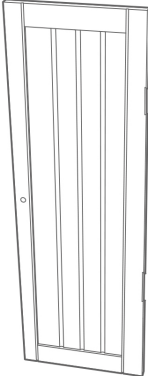
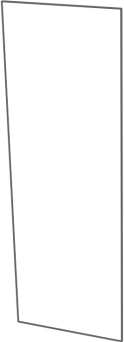







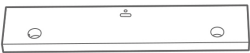

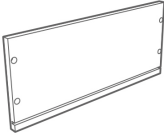

Care should be taken when assembling and appropriate precautions are taken when using tools to build the cabinet.

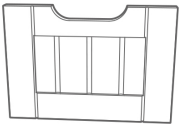
### Parts List 1

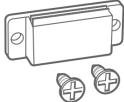
A  1x	B  1x	
C  1x	D  1x	E  1x
F  1x	G  1x	H  2x
I  2x		

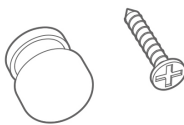
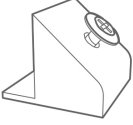
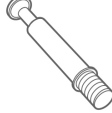

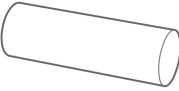
# Parts List 2

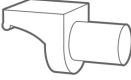
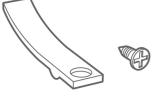
J  1×	K  1×	L  4×	
M  4×	N  4×	O  4×	
P  4×	Q1  1×	Q2  1×	R  2×
S  1×	T1  4×	T2  12×	
T3  12×	T4  27×	T5  2×	
T6  32×	T7  4×	T8  4×	

## Assembly

### Step 1

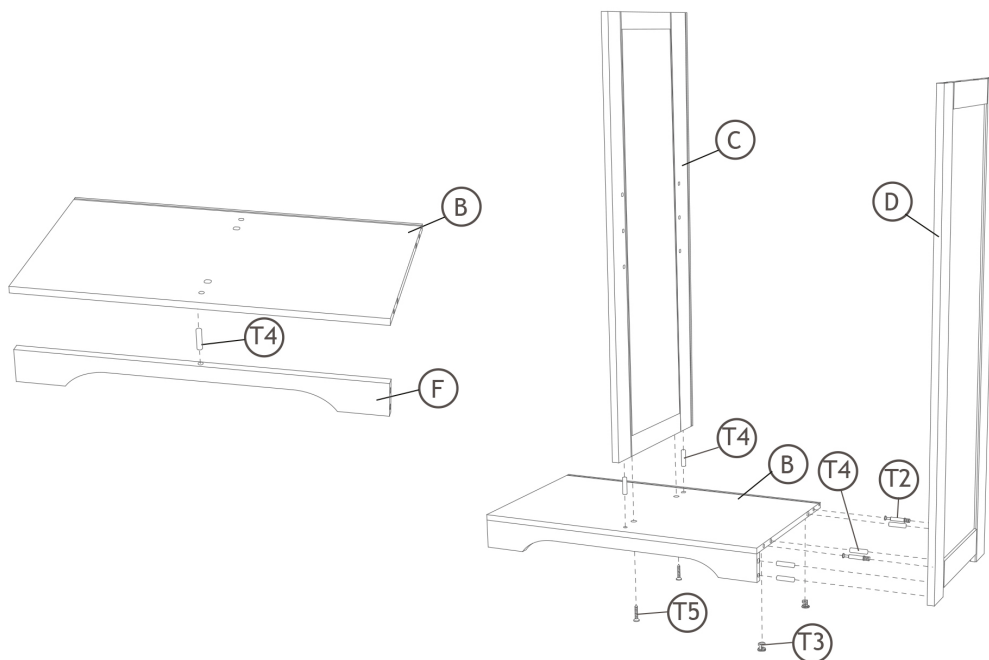

## Step 2

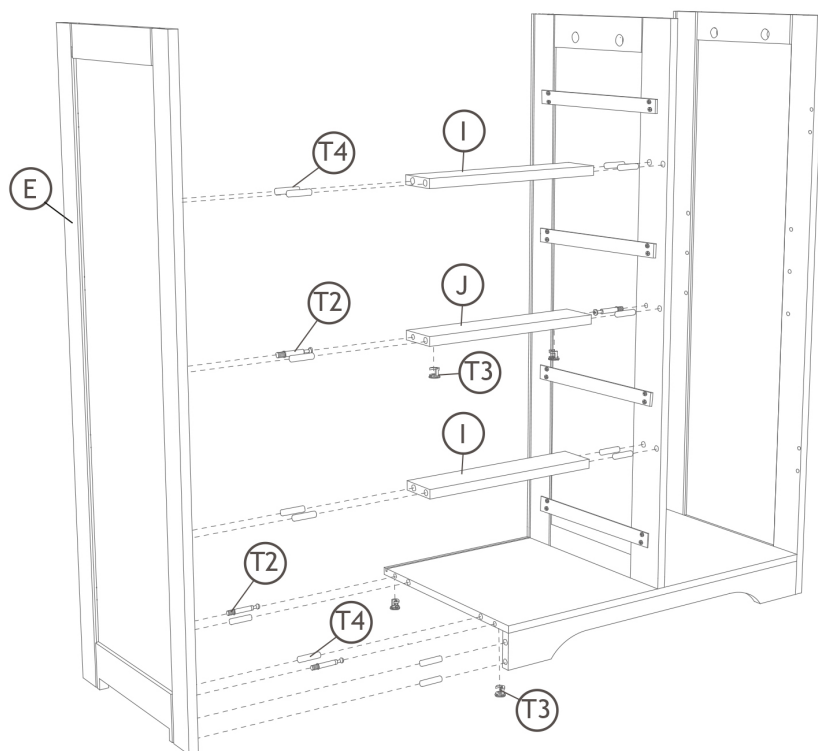

## Step 3

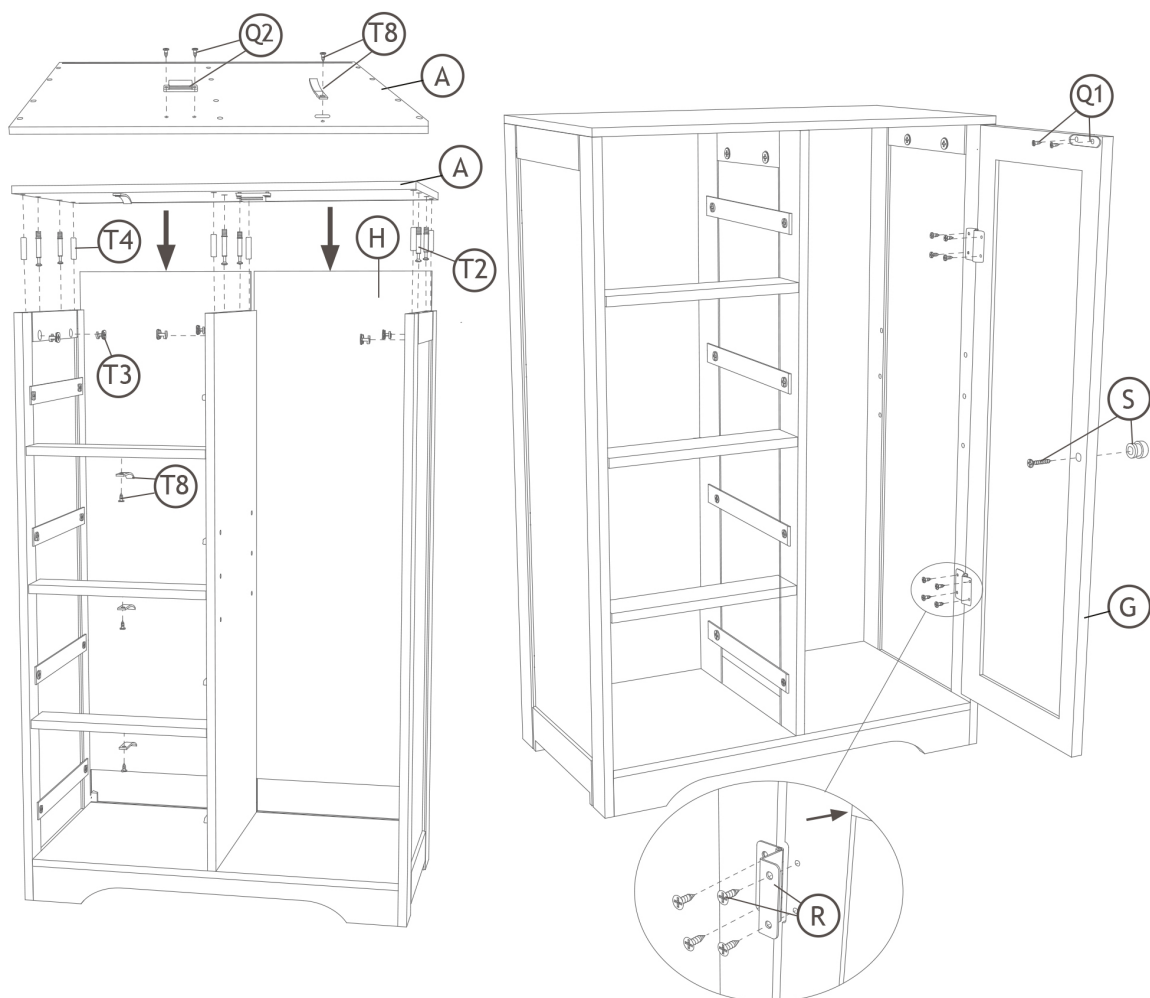

## Step 4

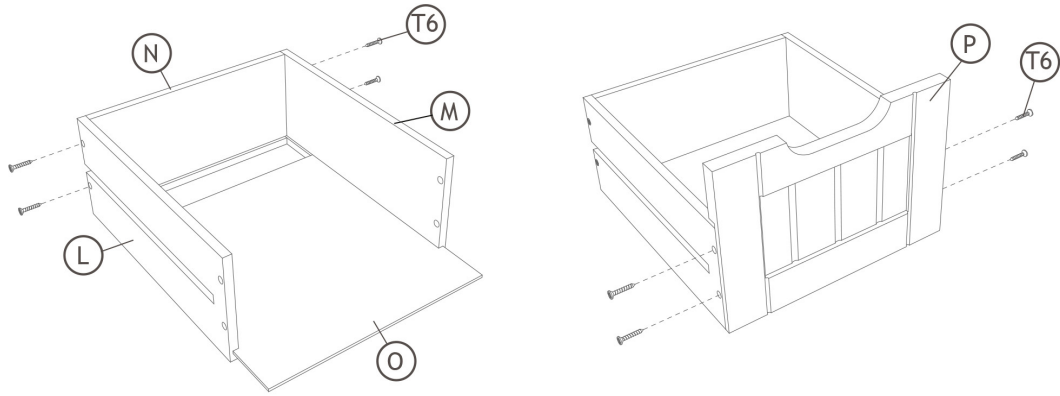

## Step 5

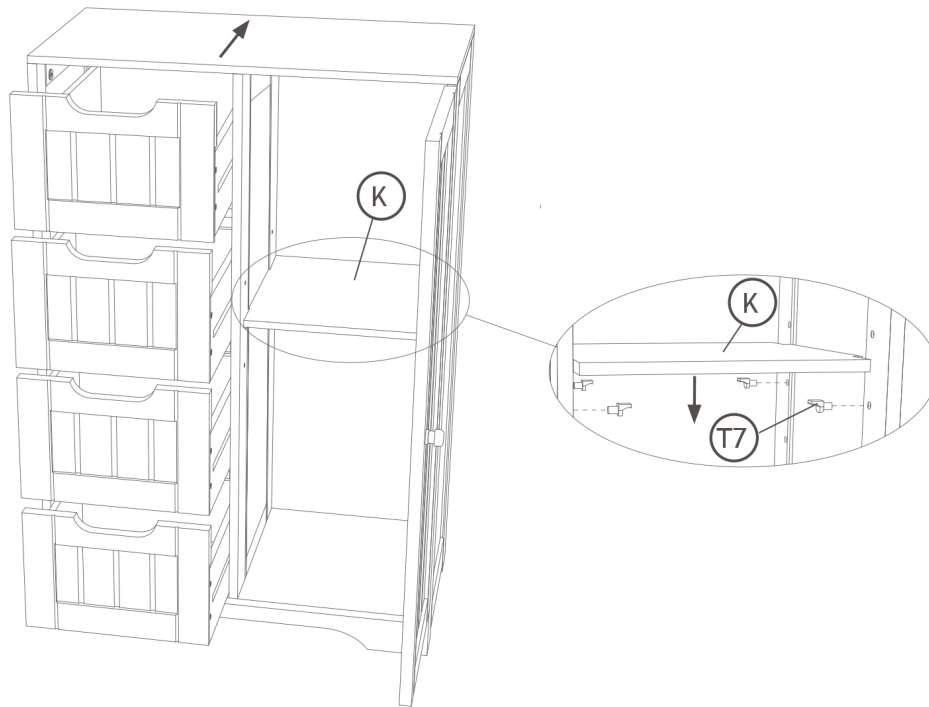

## Step 6

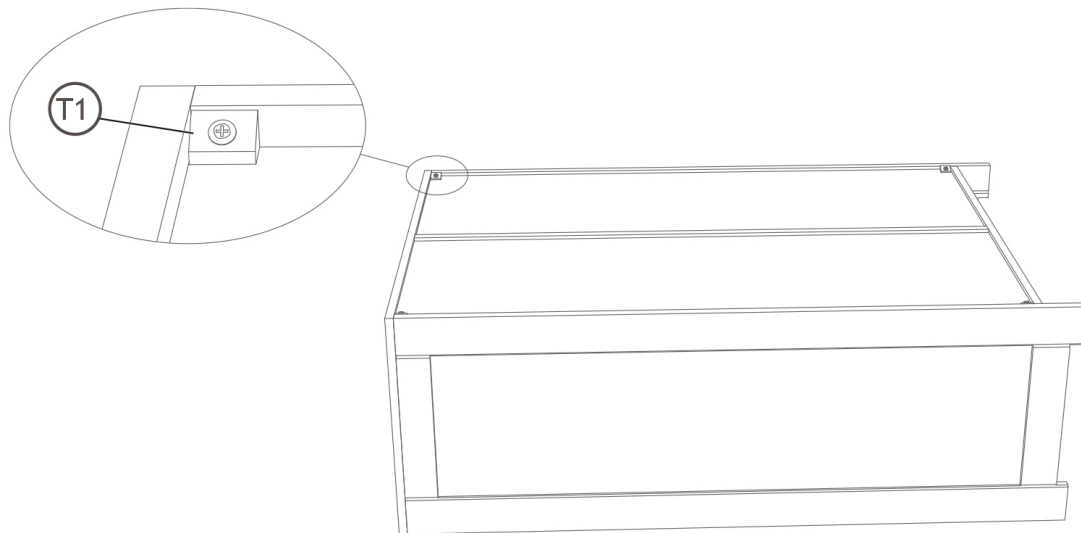

### Warranty

Electrovision guarantees the product free from defects in materials and workmanship for a period of one year. Should this unit be operated under conditions other than those recommended or attempts made to service or modify the unit, then the warranty will be rendered void. The product you buy may sometimes differ slightly from illustrations. This warranty is in addition to, and does not affect, your statutory rights.