

# LUXFORM<sup>®</sup>

LIGHTING





Québec

**LUXFORM**<sup>®</sup>  
GLOBAL BV

Luxform Global BV Transportstraat 1 8263 BW Kampen The Netherlands

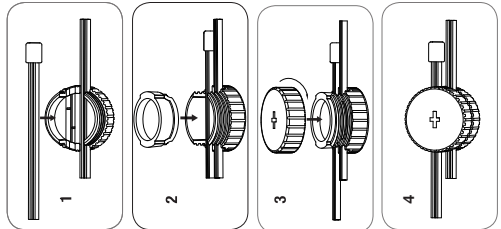
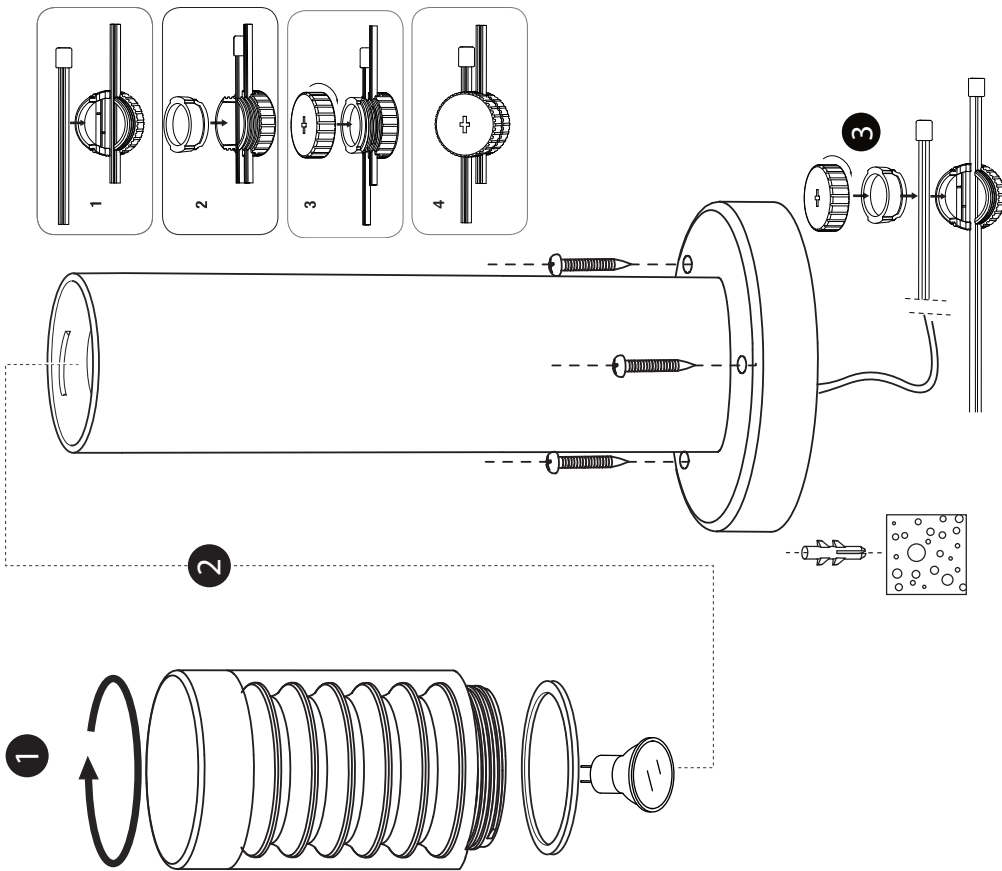





- 

MR16 GU5.3

L6
- 

C1
- 

SPT-1



C2
- 

MAX 3W

L1
- 

2Y

Garantie

Warranty
- 
- 



F

M2
- 

M5
- 

M12
- 

M18
- 

M19
- 
- 

M2