

REVISION			
SYM	DESCRIPTION	DATE	APP

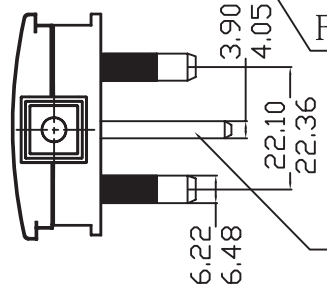

FUSE: 3A TO BS1362 (LYVIA)

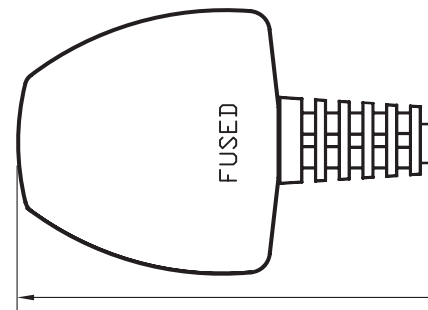
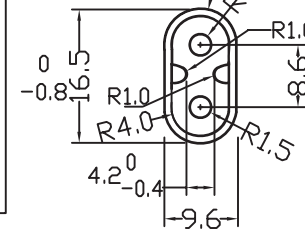
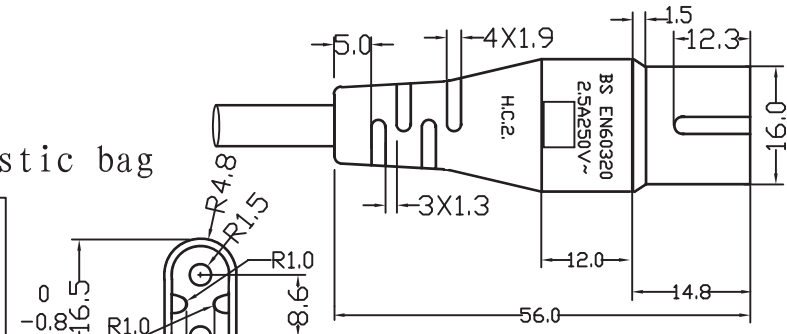
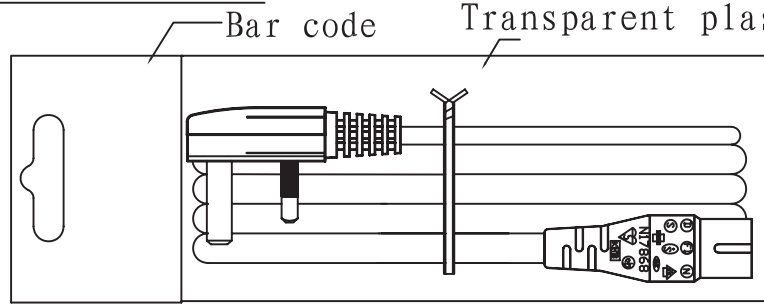

2000±20mm

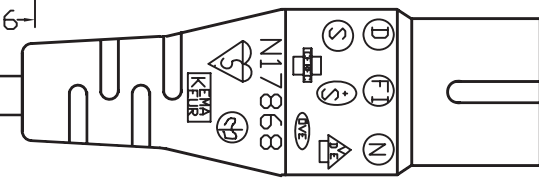

CABLE MARKING: H03VVH2-F 2X0.75mm<sup>2</sup> ◁ VDE ▷ N19626 CCC A030116 NO. 2003010105097406 227 IEC  
52(RVV) 300/300V 2X0.75mm<sup>2</sup>

CABLE COLOR: BLACK

# Electrovision

UNLESS SPECIFIED ALL DIMENSIONS ARE IN MM TOLERANCE ON :

DWG SIZE: A4 ISSUE NO: A

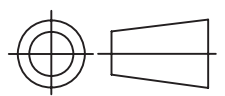

CUSTOMER: ELECTROVISION  
PART NO: QTY REQ'D PER UNIT: 1

CUSTOMER PART NO.: A145DB  
FINAL PROTECTIVE FINISH:  
DRAWINGS NO: -ELECTROVISION-63

SCALE N.T.S  
SHEET 1 OF 1

DWG, WANG 2016/04/19  
CHK,  
APP,